

TECHNICAL INFORMATION AND SERVICE DATA



Models 511-M & 713-C

**FIVE VALVE, TWO BAND, BATTERY/VIBRATOR
OPERATED SUPERHETERODYNES**

**ISSUED BY
AMALGAMATED WIRELESS (A/SIA.) LTD.**

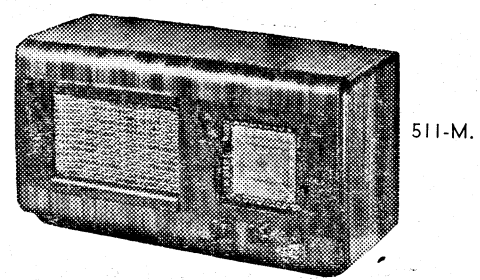

511-M.

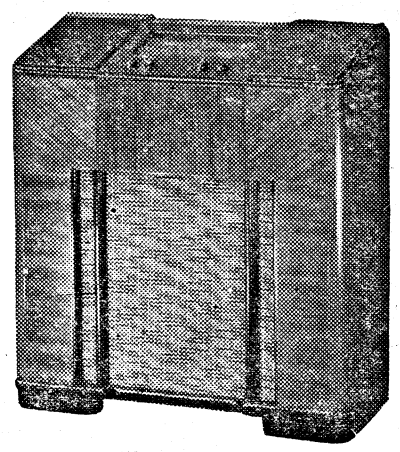

713-C.

ELECTRICAL SPECIFICATIONS.

FREQUENCY RANGES Medium Wave 1600 - 540 Kc/s. (187.5-555M).
Short Wave 18-6 Mc/s. (50-16M).
INTERMEDIATE FREQUENCY: 455 Kc/s.

DIAL LAMP (2) 2.0 volt, 0.06 Amp.
FUSE:
Battery Operation 1/4 - 3/8 Amp.
Vibrator Operation 3 Amp.

BATTERY COMPLEMENT:
There are three modes of operation—two employing "B" batteries and the third a Vibrator Power Unit. Battery cables are available fitted with telephone tips for batteries fitted with Fahnestock clips, or with plugs for socket-type batteries.
The batteries used and their respective cables are as follows:—

VALVE COMPLEMENT:
(1) 1A7GT Converter.
(2) 1P5GT I.F. Amplifier.
(3) 1P5GT I.F. Amplifier.
(4) 1H5GT Detector, A.V.C., and A.F. Amplifier.
(5) 1Q5GT Output.

BATTERY OPERATION:

	Cable with tips.	Cable with plugs.
(1) 1—4 volt accumulator 2—45 volt "B" batteries	19183	19803
(2) 1—1.5 volt dry cell "A" battery 2—45 volt "B" batteries	19182	19801

VIBRATOR A.W.A./OAK Type V6804
LOUDSPEAKER (Permanent Magnet):
Model 511-M. 5 inch—Code No. AC25, AC26 and AC32.
Model 713-C. 12 inch—Code No. AU28, AU29.
Transformer XA8. Transformer TU2.
V.C. Impedance 3 ohms at 400 C.P.S. V.C. Impedance 12 1/2 ohms at 400 C.P.S.

NOTE: If a 1.5 volt dry cell "A" battery is used it is necessary, if dial illumination is required, to remove the dial lamp cable from the terminals on top of the chassis and to connect the cable to the outer terminals of a 4.5 volt battery—see diagram "Battery Connections."

UNDISTORTED POWER OUTPUT 250 milliwatts
CONTROLS:

VIBRATOR POWER UNIT OPERATION:
1—4 volt accumulator.
Vibrator Power Unit No. 19190.

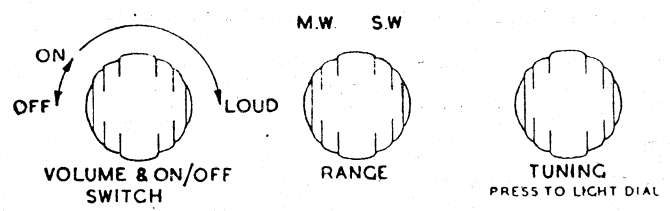

BATTERY CONSUMPTION:
Battery Operation:
4 volt "A" battery 0.2 Amp.
1.5 volt "A" battery 0.3 Amp.
"B" battery 12 mA.
Vibrator Operation 0.8 Amp.

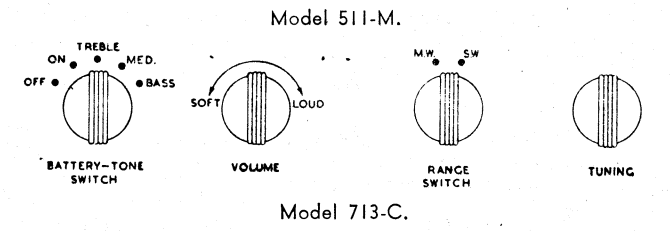

Model 713-C.

CIRCUIT DIAGRAM — Model 511-M

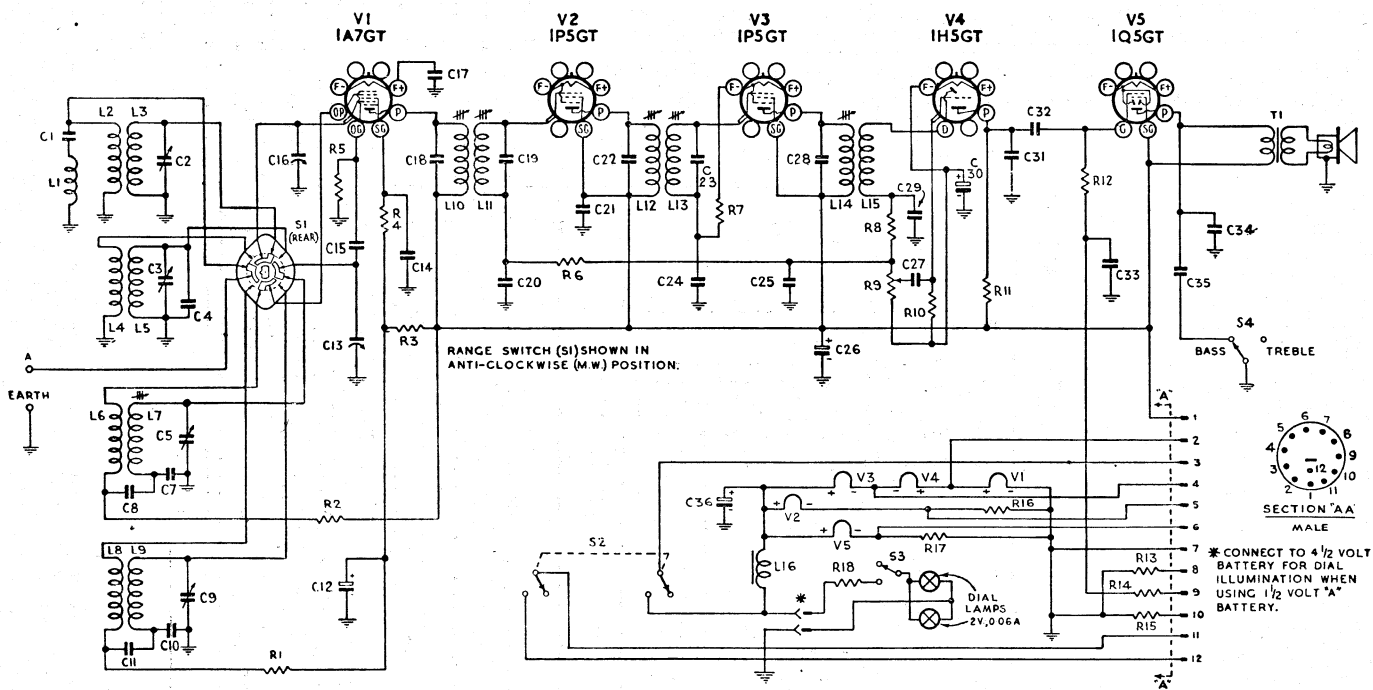

PLUGS VIEWED FROM WIRING SIDE.

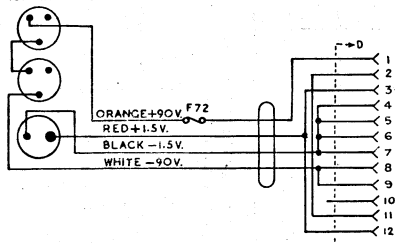

BATTERY CABLE No. 1980I

PLUGS VIEWED FROM WIRING SIDE.

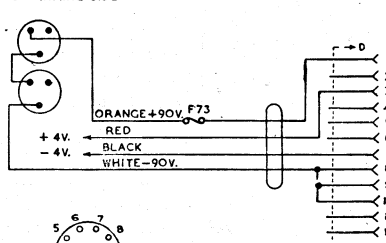

BATTERY CABLE No. 19803



VIBRATOR POWER UNIT No. 19190

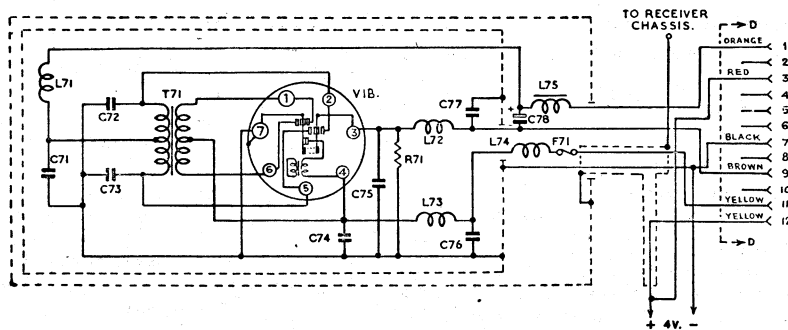

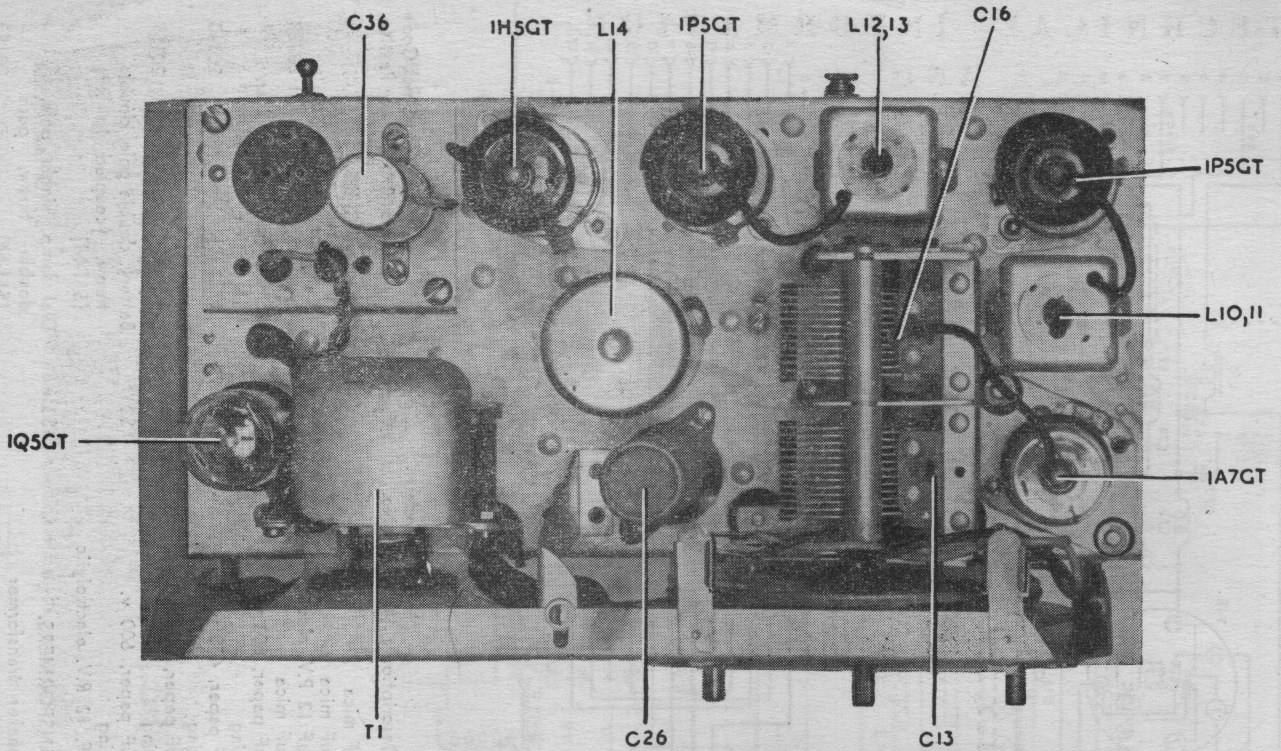

CHASSIS (TOP VIEW).

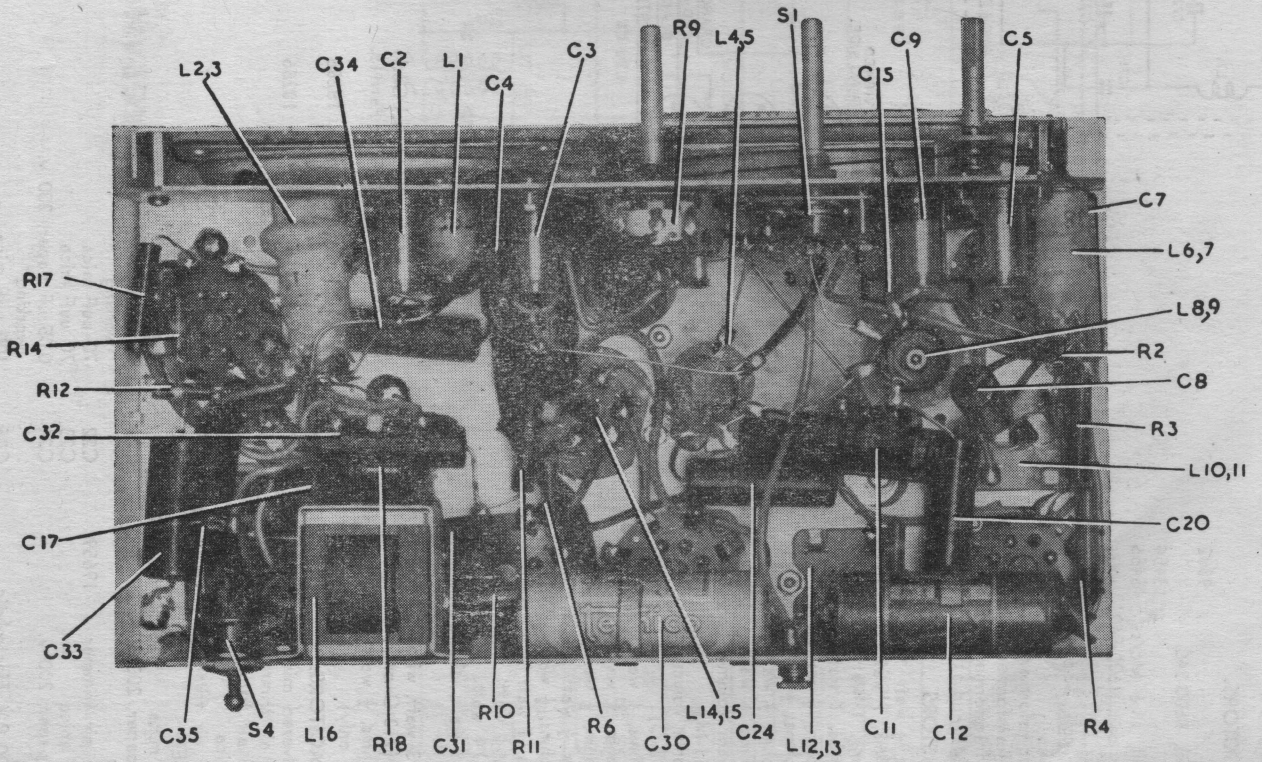

CHASSIS (UNDERNEATH VIEW).

NOTE: The above photographs are Top and Bottom views of the 511-M. The 713-C differs from these in that S4 is deleted and incorporated in the Battery/Tone Switch as given in the circuit code. Also the speaker is mounted inside the cabinet and not on the chassis as shown in the above photographs.

MECHANICAL SPECIFICATIONS.

	Height.	Width.	Depth.
Cabinet Dimensions (inches)—			
511-M	9½	17¾	6¾
713-C	32	30	13
Chassis Base Dimensions (inches)			
	2½	11	5½
Overall Chassis Height (inches)			
	7		

	Height.	Width.	Depth.
Carton Dimensions (inches)—			
511-M	9½	17¾	10
713-C	33	31¾	14¾
Weight (nett lbs.)—			
511-M	14		
713-C	56		
Cabinet Finish—			
511-M		Walnut Veneer	
713-C		Walnut Veneer	

GENERAL DESCRIPTION.

The models 511-M and 713-C are table and console models respectively. They may be either battery or vibrator operated, and for battery operation either a 4 volt accumulator, or a 1.5 volt dry cell "A" battery may be used, the necessary circuit modification being effected by the battery cable employed.

Battery connections are shown in the accompanying diagrams.

Design features include: Tropic proof construction, automatic volume control, magnetite cores in I.F. transformers and broadcast oscillator coil and air-dielectric trimming capacitors.

Model 713-C employs straight line, edge-lighted dial with metropolitan stations printed in 1/8 inch high characters.

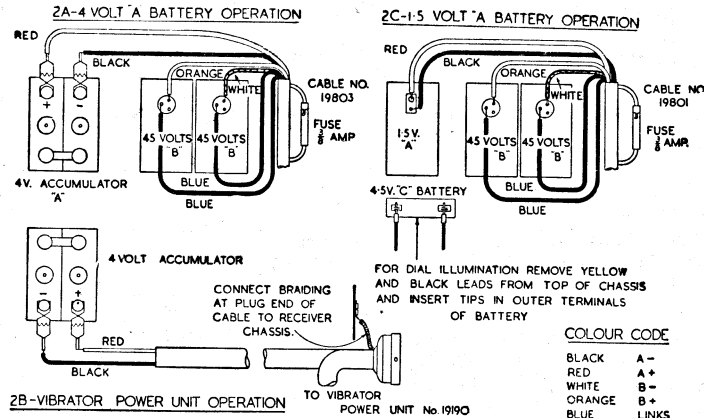

FIG. 2 - BATTERY CONNECTIONS

20380

ALIGNMENT PROCEDURE.

Manufacturer's Setting of Adjustments.

The receiver is tested by the manufacturers with precision instruments, and all adjusting screws are sealed. Re-alignment should be necessary only when components in tuned circuits are repaired or replaced, or when it is found that the seals over the adjusting screws have been broken.

It is especially important that the adjustments should not be altered unless in association with the correct testing instruments listed below.

Under no circumstances should the plates of the ganged tuning capacitor be bent, as the unit is accurately aligned during manufacture and cannot be re-adjusted unless by skilled operators using specialised equipment.

For all alignment operations, connect the "low" side of signal generator to the receiver chassis, and keep the generator output as low as possible to avoid A.V.C. action. Also, keep the volume control in the maximum clockwise position.

Testing Instruments.

- (1) A.W.A. Junior Signal Generator, type 2R3911, or
- (2) A.W.A. Modulated Oscillator, type J6726.

If the modulated oscillator is used, connect an 0.25 megohm non-inductive resistor across the output terminals, and, for Short Wave alignment, an additional 400 ohms non-inductive resistor in series with the "high" output lead of the instrument.

- (3) Output Meter.

The instrument recommended should have an output impedance of 12,000 ohms and a range of 5-3,000 milliwatts. The meter should be connected across the primary of the loudspeaker transformer with the voice coil of the loudspeaker open-circuit.

If the output meter used is one which does not impress a load on the anode circuit of the output valve, it will not be necessary to open-circuit the voice-coil.

ALIGNMENT TABLE.

Order.	Connect "high" side of Generator to:	Tune Generator to:	Set Receiver Dial to:	Adjust for Maximum Peak Output.
1	1A7GT Grid *	455 Kc/s	540 Kc/s	L14 Core
2	1A7GT Grid *	455 Kc/s	540 Kc/s	L13 Core
3	1A7GT Grid *	455 Kc/s	540 Kc/s	L12 Core
4	1A7GT Grid *	455 Kc/s	540 Kc/s	L11 Core
5	1A7GT Grid *	455 Kc/s	540 Kc/s	L10 Core
Repeat the above adjustments until the maximum output is obtained				
6	Aerial Terminal	600 Kc/s	600 Kc/s	L.F. Osc. Core Adj. (L7)‡
7	Aerial Terminal	1500 Kc/s	1500 Kc/s	H.F. Osc. Adj. (C5)
8	Aerial Terminal	1500 Kc/s	1500 Kc/s	H.F. Aer. Adj. (C2)
Repeat adjustments 6, 7 and 8				
9	Aerial Terminal	16 Mc/s	16 Mc/s	H.F. Osc. Adj. (C9)†
10	Aerial Terminal	16 Mc/s	16 Mc/s	H.F. Aer. Adj. (C3)§

* With grid clip connected. A 0.001 uF capacitor should be connected in series with the "high" side of the test instrument.

‡ Rock the tuning control back and forth through the signal.

† Use the minimum capacity peak if two can be obtained. Check to determine that C9 has been adjusted to correct peak by tuning the receiver to approximately 15.09 Mc/s, where a weaker signal should be received.

§ Use maximum capacity peak if two can be obtained.

Loudspeaker Service.

It is inadvisable to attempt loudspeaker repairs other than replacement of the transformer. The fitting of a new cone should be done only by Service Departments suitably equipped to do the work.

Chassis Removal.**Model 511-M:**

First remove the knobs and felt washers—each knob is held by a set screw. Then, remove the two screws from underneath the cabinet and withdraw the chassis.

Model 713-C:

- (1) Remove the knobs and felt washers. The knobs are each held by set screws.
- (2) Disconnect the loudspeaker cable.
- (3) The chassis is held in the cabinet by four winged nuts, two at each end of the dial frame assembly.

Dial Pointer Adjustment.**Model 511-M:**

To shift the position of the dial pointer, loosen two screws in the rear of the drive drum—see accompanying diagram—move the drum to the required position, and retighten the screws.

Model 713-C:

The dial pointer is held in position on the drive cord by two rubber-lined clips. To alter the position of the pointer, loosen the holding clips slightly, and move the pointer in the required direction. It is important to re-clamp the clips after any adjustment of the dial pointer.

To replace the Tuning Drive Cord, follow the diagram which is affixed to the back of the Dial Frame assembly. This shows the route of the cord and the method of attachment.

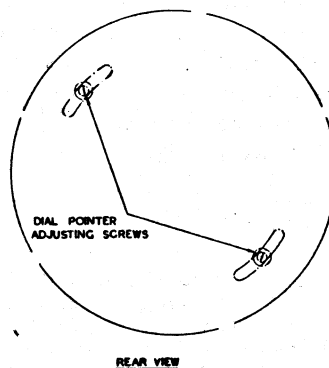
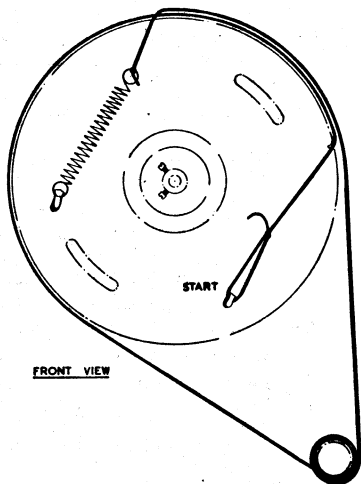

CIRCUIT DIAGRAM — Model 713-C

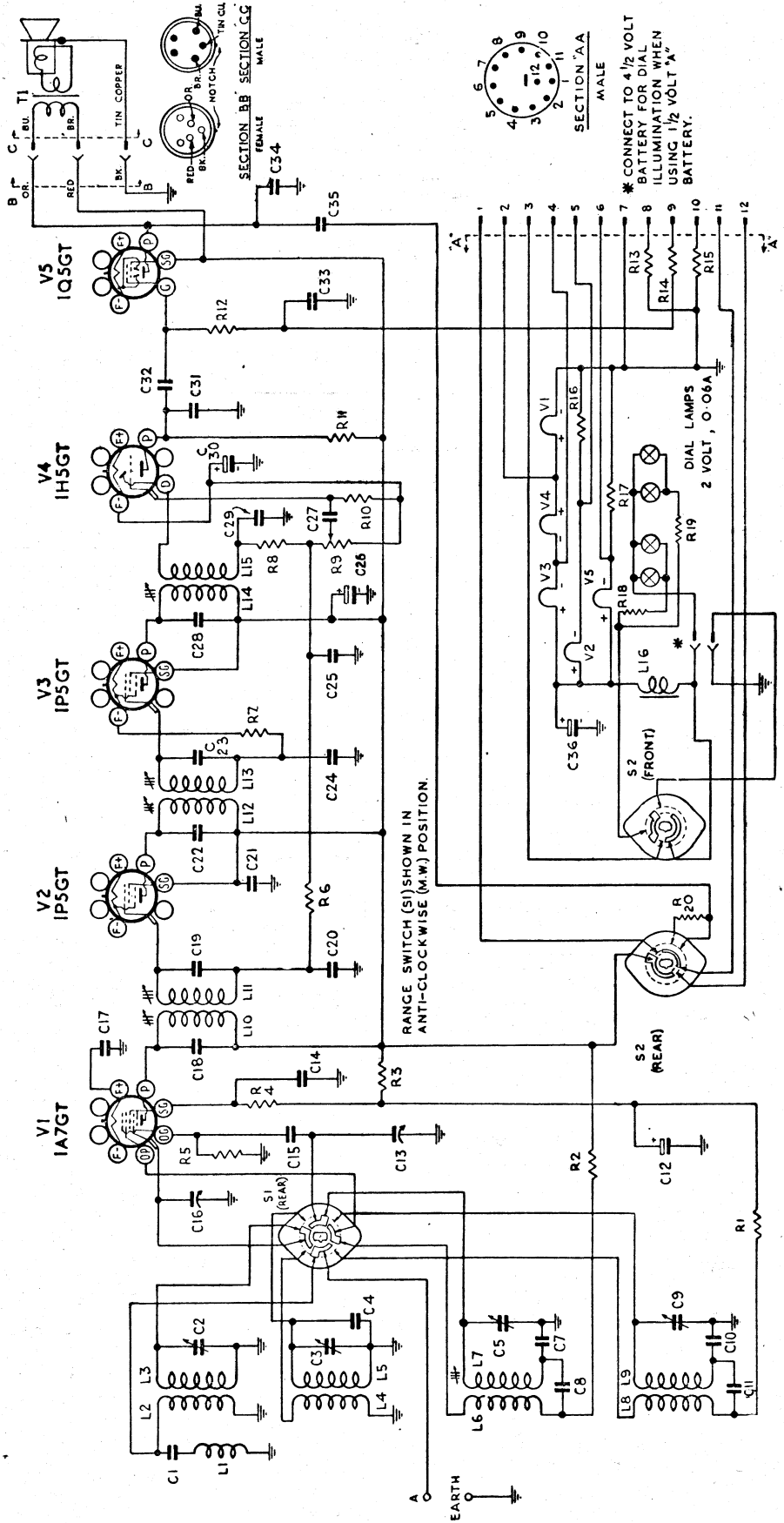

SOCKET VOLTAGES AND CURRENTS

Valve.	Bias Volts.		Screen to Chassis Volts.		Anode to Chassis Volts.		Anode Current mA.		Filament Volts.
	B	V	B	V	B	V	B	V	
1A7GT Converter	0	0	40*	40*	85	90	0.3	0.4	1.4
Oscillator M.W.	—	—	—	—	50	50	0.8	0.8	—
S.W.	—	—	—	—	75	75	1.2	1.1	—
IP5GT I.F. Amplifier	0	0	90	90	85	85	1.3	1.1	1.4
IP5GT I.F. Amplifier	0	0	90	90	85	85	1.3	1.5	1.4
IH5GT Detector	0	0	—	—	50	50	0.03	0.03	1.4
IQ5GT Output	-4.5*	-4.5*	90	90	80	85	9	9	1.4

Measured with no signal input. Volume Control maximum clockwise.

* These readings may vary, depending on the resistance of the voltmeter used.

D.C. RESISTANCE OF WINDINGS.

Winding.	D.C. Resistance in ohms
Aerial Coil (M.W.)—	
Primary (L2)	27
Secondary (L3)	5
Aerial Coil (S.W.)—	
Primary (L4)	3
Secondary (L5)	*
Oscillator Coil (M.W.)—	
Primary (L6)	2.5
Secondary (L7)	7
Oscillator Coil (S.W.)—	
Primary (L8)	*
Secondary (L9)	*
I.F. Transformer Windings	8
I.F. Filter (L1)	45†
Smoothing Choke (L16)	*
Smoothing Choke (L75)	200
R.F. Filter Choke (L73, L74)	*
R.F. Filter Choke (L71, L72)	9
Loudspeaker Input Transformer (T1)	
XA8 Primary	650
XA8 Secondary	*
TU2 Primary	490
TU2 Secondary	*
Vibrator Transformer (T71)	
Primary	*
Secondary	300

The above readings were taken on a standard chassis, but substitution of materials during manufacture may cause variations, and it should not be assumed that a component is faulty if a slightly different reading is obtained.

* Less than 1 ohm.

† On some receivers this reading may be as high as 60 ohms.

MECHANICAL REPLACEMENT PARTS.

Item.	Part No.	Item.	Part No.
Cabinet, table model	C76	Drive drum assembly—	
Cabinet, console model	C78	Table model	20130
Cable, battery—		Console model	9090
4 volt	19183	Fuse	58940
1.5 volt	19182	Knob—	
Cable, volume control	15464	Table model	17603
Cable, loudspeaker—		Console model	4589
Console model	19188	Strip, tag—	
Chassis end	20124	Table model, 3 way	8821
Table model	20124	1 way	7628
Console model—left hand	20316	Console model, 4 way	10236
Right hand	20318	1 way	7628
Dial scale—		Socket, valve	4704
Table model	20008	Socket, valve, cushion	20142
Console model	20334	Spindle, tuning drive—	
Dial pointer assembly—		Table model	20140
Table model	20132	Console model	20339
Console model	20331	Vibrator power unit	19190
		Terminal, aerial	17717